



SARMAAFARIN

Room Fan Coil Unit
Ducted Fan Coil Unit

AEROACOUSTIC



Certificate No.: 9190.C308
FORM SSI - 42 (1400)

فن کویل‌های اتاقی و کانالی

42A, 42H, 42N

42A (vertical) and 42H (horizontal) fan-coil units are room terminals ideally suited for air conditioning individual room in offices, motels, hotels, hospitals or apartments. Units are available in five sizes handling 210, 330, 430, 600 and 800 cfm (high fan speed). Base units include double-width fan, specially designed scroll, and resiliently mounted psc motor. Al secured to condensate pan or plate to form a single subassembly. This subassembly is attached to an insulated metal casing containing a 3-row cooling/heating coil with air vent and sweat connections (right or left-hand). A 3 - speed unit - mounted fan switch, cleanable filter, and secondary condensate pan complete the vertical assembly. A movable electric junction box completes the horizontal assembly.

42A and 42H

Full Line of Equipment to Cover Entire Job Potential Numerous models, options and accessories to adapt unit to wide range of applications. Fewer Watts per cfm , standard 3- speed psc fan motors are designed for minimum current draw

High - Capacity Performance – Consistent, dependable performance is ensured by use of high - efficiency, field-reversible coils.

Low First Cost – These compact units with their factory - installed controls require minimum space and may be installed at minimum expense.

Quiet Operation – Low noise level is achieved by use of resiliently mounted slow - speed motors, built - in motor speed controls, internal insulation, and low - velocity air patterns.

Precision-Made Die-Formed Enclosures – Only 9 inches deep, each cabinet is factory assembled to base unit. Cabinet finish includes bonderizing with furnace baked paint.

42A Vertical Unit

Decorator Color – Standard white color.

Removable Condensate Pan and Fan Assembly – May be quickly detached from base unit for servicing.

Automatic Air Vent – Eliminates need to opening by inserting screwdriver thru discharge grille.

42H Horizontal Unit

Lightweight and Compact – Unit can usually be handled with ease by one man.

Simplified Water and Condensate Connections – Drain pan can be dropped by removing two bolts, giving ample room for water connections. The condensate line slips into an antisweat outlet stub and is secured by a factory- furnished, self-tightening wire clamp.

Extended Discharge – Eliminates need for special duct or grille adapters.

42A	B	020	LH
Series	Unit Type	Size (cfm)	Coil
Vertical	B: Top	020: 200	LH: Left
	Discharge	030: 300	Hand
	C: Front	040: 400	RH: Right
	Discharge	060: 600	Hand
		080: 800	

42H	B	020	LH
Series	Unit Type	Size (cfm)	Coil
Horizontal	A: Concealed compact	020: 200	LH: Left
	Version	030: 300	Hand
	B: Exposed with	040: 400	RH: Right
	Cabinet	060: 600	Hand
	C-PLN:	080: 800	
	Concealed with		
	Plenum		

42AB & 42AC Model			020	030	040	060	080
Fan	Air Delivery (cfm)	High	210	330	430	600	800
		Med.	165	255	330	410	640
		Low	120	190	250	300	450
Type		Centrifugal					
Qty		1	1	2	2	2	
Coil	No. of Rows		3	3	3	3	3
	Area (sq ft)		0.8	1.19	1.42	1.93	2.51
	Connection (in)	Supply	½ FPT				
		Return					
Drain		¾ OD					
Qty.		1	1	1	1	1	
V-ph-Hz		220-1-50					
HP		1/45	1/30	1/20	1/16	1/6	
Name Plate Amps.		0.4	0.4	0.5	0.55	1.3	
Filter	Qty		1	1	1	1	1
	Size (in)		8×7/8×19¾	8×7/8×26¾	8×7/8×30¾	8×7/8×39¾	8×7/8×49¾
Dimension	A (mm)		851	1029	1130	1359	1613
	B (mm)		227	227	227	227	227
	C (mm)		635	635	635	635	635
	Approx. Wt (kg)		29	33	38.5	47.2	54.5
	Air Grill Free Area (sq in)	Disch.	53.3	78.4	89.5	113.6	144.7
Recirc.		70	95	109	140	176	

* For more information about selection procedure and capacity tables visit www.ssi.co.ir

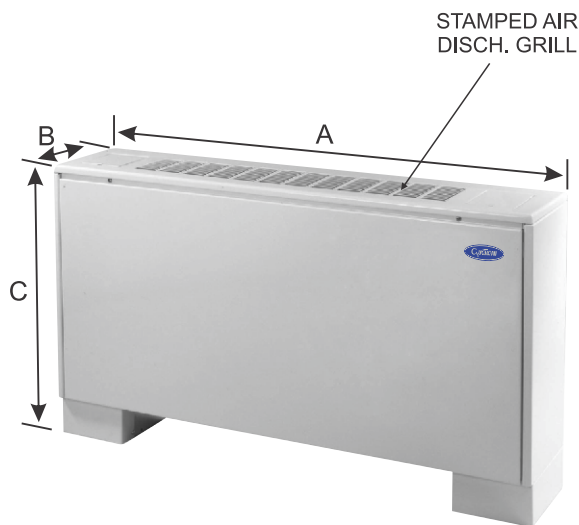

42AB

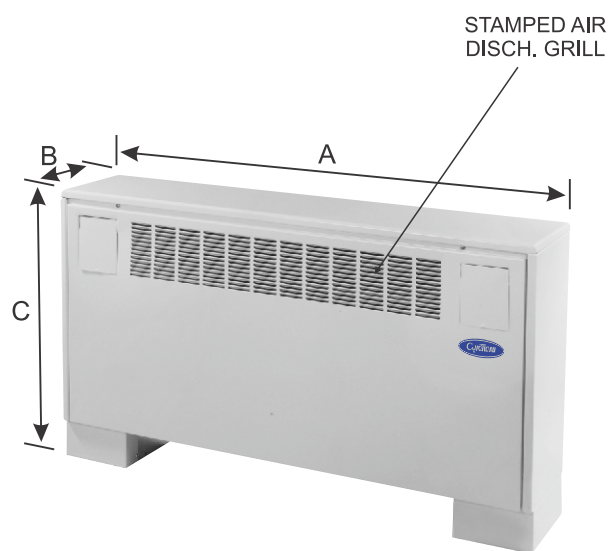

42AC

42HA Model			020	030	040	060	080
Fan	Air Delivery (cfm)	High	210	330	430	600	800
		Med.	165	255	330	410	640
		Low	120	190	250	300	450
	Type	Centrifugal					
	Qty	1	1	2	2	2	
Coil	No. of Rows		3	3	3	3	3
	Area (sq ft)		0.8	1.19	1.42	1.93	2.51
	Connection (in)	Supply	½ FPT				
		Return					
Drain		¾ OD					
Motor	V-ph-Hz		220-1-50				
	HP		1/45	1/30	1/20	1/16	1/6
	Name Plate Amps.		0.4	0.4	0.5	0.55	1.3
Filter	Qty		1	1	1	1	1
	Size (in)		8×½×19¾	8×½×26¾	8×½×30¾	8×½×39¾	8×½×49¾
Dimension and weight	A (mm)		619	797	898	1127	1381
	B (mm)		548	548	548	548	548
	C (mm)		235	235	235	235	235
	Approx. Wt (kg)		20	24	27.5	31	36

* For more information about selection procedure and capacity tables visit www.ssi.co.ir

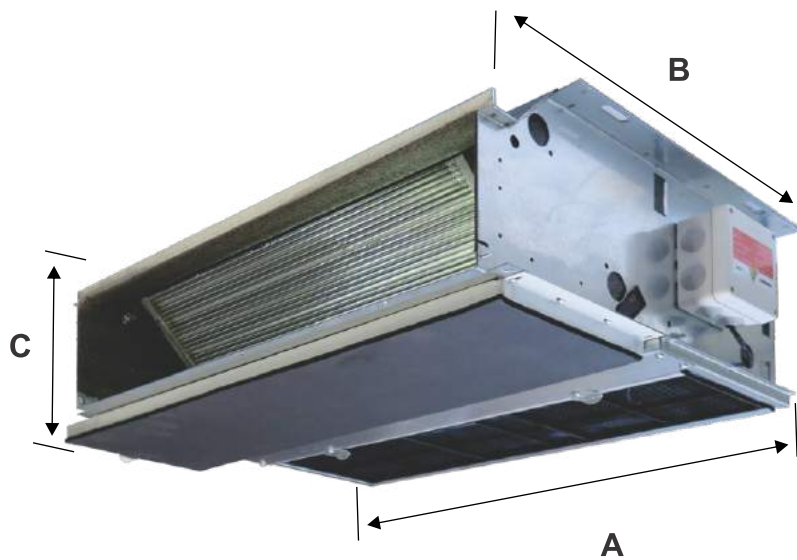

42HC-PLN Model			020	030	040	060	080
Fan	Air Delivery (cfm)	High	210	330	430	600	800
		Med.	165	255	330	410	640
		Low	120	190	250	300	450
Type		Centrifugal					
Qty		1	1	2	2	2	
Coil	No. of Rows		3	3	3	3	3
	Area (sq ft)		0.8	1.19	1.42	1.93	2.51
	Connection (in)	Supply	½ FPT				
		Return					
Drain		¾ OD					
Motor	Qty.		1	1	1	1	1
	V-ph-Hz		220-1-50				
	HP		1/45	1/30	1/20	1/16	1/6
	Name Plate Amps.		0.4	0.4	0.5	0.55	1.3
Filter	Qty		1	1	1	1	1
	Size (in)		10× ⁷ / ₈ ×17 ³ / ₈	10× ⁷ / ₈ ×17 ³ / ₈	10× ⁷ / ₈ ×17 ³ / ₈	10× ⁷ / ₈ ×17 ³ / ₈	10× ⁷ / ₈ ×17 ³ / ₈
Dimension	A (mm)		675	826	927	1156	1410
	B (mm)		511	511	511	511	511
	C (mm)		267	267	267	267	267
	Approx. Wt (kg)		14.5	17.2	20	24	30
	Air Grill Free Area (sq in)	Disch.	48.6	72.5	83.6	112.8	142.5
Recirc.		84.5	120	145	181	228	

* For more information about selection procedure and capacity tables visit www.ssi.co.ir

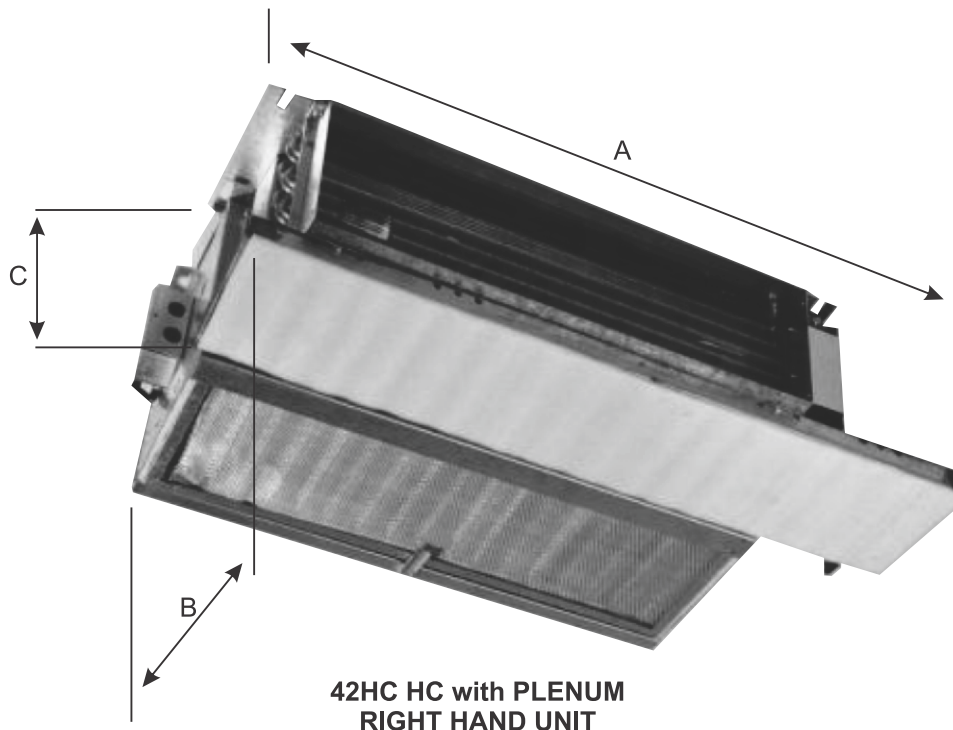

42HC-PLN Model			020	030	040	060	080
Fan	Air Delivery (cfm)	High	210	330	430	600	800
		Med.	165	255	330	410	640
		Low	120	190	250	300	450
Type		Centrifugal					
Qty		1	1	2	2	2	
Coil	No. of Rows		3	3	3	3	3
	Area (sq ft)		0.8	1.19	1.42	1.93	2.51
	Connection (in)	Supply	½ FPT				
		Return					
Drain		¾ OD					
Qty.		1	1	1	1	1	
V-ph-Hz		220-1-50					
HP		1/45	1/30	1/20	1/16	1/6	
Name Plate Amps.		0.4	0.4	0.5	0.55	1.3	
Filter	Qty		1	1	1	1	1
	Size (in)		8×7/8×19¾	8×7/8×26¾	8×7/8×30¾	8×7/8×39¾	8×7/8×49¾
Dimension	A (mm)		851	1029	1130	1359	1613
	B (mm)		578	578	578	578	578
	C (mm)		248	248	248	248	248
	Approx. Wt (kg)		32.2	37.2	43.5	53.5	62
	Air Grill Free Area (sq in)	Disch.	48.6	72.5	83.6	112.8	142.5
Recirc.		84.5	120	145	181	228	

* For more information about selection procedure and capacity tables visit www.ssi.co.ir

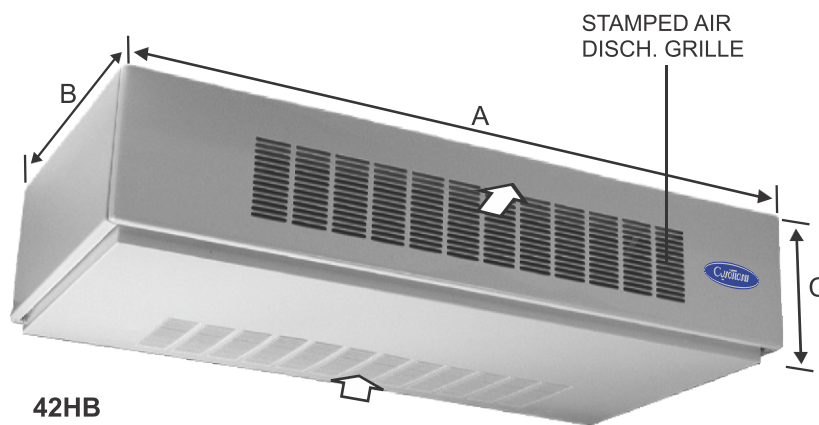

CONTROLS

Fan - Water Flow Control

The 42A, H units may be controlled by the following methods: 1- Fan Cycling - Regulates temperature by manual or thermostatic control of fan. This method is recommended only where provision is made for shutting off chilled water when the fan is off.

2- Water Flow - Regulates temperature by manual or thermostatic control of water valves without cycling of the fan. Water control packages (manual solenoid, or motorized) are factory-furnished and installed. Pneumatic piping packages are field installed. Manual

shutoff valves are included in all water-side control packages. The standard 42A,H unit is controlled by manually setting the 3-flow control is recommended to prevent unit sweating caused by continuous flow of chilled water when the fan is off. The Fan-Water Flow Control Selection table lists the component combinations available for fan cycling and/or water flow control. Read across the table to make a selection.

Control Components		VERTICAL UNIT CONTROLS				VERTICAL UNIT CONTROLS																																
Type	Method	Control Components		Change-over	Water Valve	Control Components*		Change-over	Water Valve																													
		Master	Auxiliary			Master	Auxiliary																															
Fan Cycling	Manual	Fan Switch	None	Central	Man. Shutoff	Fan Switch	None	Central	Man. Shutoff																													
						Fan Switch	None	Central	2-Wat Solenoid																													
						Fan Switch	None	Central	2-Wat Motorized																													
	Thermostatic	Fan Switch †	Thermostat, Wall	Man.	Man. Shutoff	Fan Switch	Thermostat	Auto	Man. Shutoff																													
										On-Off Toggle ‡	Thermostat ‡	Auto	Man. Shutoff	Fan Switch	Thermostat	Man.	2-Wat Solenoid																					
																		Fan Switch †	Thermostat	Auto	Man. Shutoff	Fan Switch	Thermostat	Man.	2-Wat Motorized													
On-Off Toggle ‡	Thermostat ‡	Auto	Man. 3-Way	Fan Switch	Thermostat	Man.	2-Wat Motorized																															
								Fan Switch	Thermostat, Wall	Man.	Man. 3-Way	Fan Switch	Thermostat	Man.	2-Wat Motorized																							
Water Flow Continuous Fan Operation	Manual	Fan Switch †	None	Central	Man. 3-Way	-	-									-	-																					
						Thermostatic	Fan Switch, Unit	Thermostat, Unit	Central	2-Wat Solenoid	Fan Switch	Thermostat	Auto	2-Wat Solenoid																								
															Fan Switch, Unit	Thermostat, Unit	Auto	2-Wat Motorized	Fan Switch	Thermostat	Auto	2-Wat Motorized																
																							Fan Switch, Unit	Thermostat, Unit	Auto	2-Wat Solenoid	Fan Switch	Thermostat	Auto	2-Wat Solenoid								
																															Fan Switch, Unit	Thermostat, Unit	Auto	2-Wat Motorized	Fan Switch	Thermostat	Auto	2-Wat Motorized

* Thermostats and fan speed switches for horizontal units are wall mounted.

† Fan speed switch with no OFF position.

‡ Provides Hi-Lo cooling and Lo-Off heating fan control; thermostat, On-Off toggle and changover are unit mounted.

The 42N product range combines aesthetic and attractive design with versatility to satisfy any application need, from large office buildings or hotels to shops and residential applications.

This new product series is characterized by concentrated, innovative technology, unusual for a simple product like a fan coil. The result is a product that is easy to select and install.

It is available in seven sizes, with an air range from 90 l/s to 440 l/s (190 to 930 cfm) at high fan speed.

Two types of fans are available, a tangential fan for size 16 to 50, ideal for applications where low noise level is the most important selection parameter, and a centrifugal fan, available for sizes 60 and 75, for applications where static pressure and air flow are the main requirements.

The two fan versions are available in any combination, from cabinet models for floor, wall or under-ceiling installation to models without cabinet for furred-in installation.

Features

- With its sleek styling the 42N blends in perfectly with any room decor. The steel panels are protected by a high-quality paint finish.
- The flexibility of the unit drain pan allows the same unit to be installed in a vertical or horizontal position without the need for a dedicated accessory.
- The 42N units have been designed for extremely quiet operation with sound (pressure and power) levels that set new standards in the industry. The tangential fan with its unique uneven spacing between blades (up to size 33) ensures almost noiseless operation. Particular attention has been given to the low fan speed, typically used at night.
- **Pleated filter:** The standard filter for the 42N series is a complete new concept: the filtration surface is pleated, resulting in a 87% larger surface than a conventional filter with the following additional advantages:

- Lower air flow per unit area, resulting in lower pressure drop and reduced noise level

- The average interval between filter cleaning is three times longer, compared to standard filters.

- The filter material is polypropylene and the grade is EU1.

- **Filter position:** In the 42N series the filter is located at the bottom of the unit. Cleaning is easy: once the two screws at the either side of the filter have been removed, the filter frame can be pulled down and the filter can be removed easily. Re-assembly is just as easy, reversing the sequence.

The filter and filter position within the unit are designed to prevent air bypass around the filter, to ensure that the air is always filtered and clean.

- **Ease of installation:** the 42N series fan coils are extremely easy to install. For horizontal under-ceiling installations with cabinet ceiling-void application the installer's task has been significantly simplified.

Robust hooks allow easy and fast attachment of the unit: the installer only has to place it in a horizontal position. No calculation is needed to determine the correct slope for proper condensate water drainage.

For concealed ducted applications, both air intake and outlet can be mounted on the unit before installing them together as a single piece in the false ceiling.

Even the installation of floor-mounted units is now easier the new hook dimensions and positions help fixing the units firmly against the wall.

All these technical improvements minimise installation time and improve the long-term reliability, avoiding small mistakes that could impair the reliability of installed units over time.

42N	F	16	S	F	U
Series	Unit Type	Size (cfm)	Version	Coil	Control
	Z: Exposed with Cabinet	16: 191 25: 278 33: 335	S: Standard	F: Left Hand G: Right HAnd	
	F: Concealed	43: 481 50: 513 60: 718 75: 927			

PHYSICAL DATA



42NZ Model			16	25	33	43	50	60	75
Fan	Air Delivery (cfm)	High	191	278	335	481	513	718	927
		Med.	146	210	271	380	416	577	695
		Low	91	153	147	235	271	371	483
	Type	Tangential						Centrifugal	
	Qty	1	1	1	1	1	2	2	
Coil	No. of Rows		3	3	3	3	3	3	3
	Area (sq ft)		1.1	1.7	1.7	2.2	2.2	2.8	2.8
	Connection (in)	Supply	¾NPT	¾NPT	¾NPT	¾NPT	¾NPT	¾NPT	¾NPT
		Return	¾NPT	¾NPT	¾NPT	¾NPT	¾NPT	¾NPT	¾NPT
Drain		½	½	½	½	½	½	½	
Motor	Qty.		1	1	1	1	1	1	1
	V-ph-Hz		220-1-50	220-1-50	220-1-50	220-1-51	220-1-52	220-1-50	220-1-50
	Power Input (w)		32	32	44	57	69	113	164
	Current drawn (A)		0.14	0.15	0.19	0.25	0.31	0.51	0.72
Filter	Qty		1	1	1	1	1	1	1
	Size (mm)		189×391	189×591	189×591	189×790	189×790	189×990	189×990
Dimension	A (mm)		830	1030	1030	1230	1230	1430	1430
	B (mm)		220	220	220	220	220	220	220
	C (mm)		657	657	657	657	657	657	657
	D (mm)		557	557	557	557	557	557	557
	Approx. Wt (kg)		17	19	19	22	22	35	35

* For more information about selection procedure and capacity tables visit www.ssi.co.ir



PHYSICAL DATA



42NF Model			16	25	33	43	50	60	75
Fan	Air Delivery (cfm)	High	191	278	335	481	513	718	927
		Med.	146	210	271	380	416	577	695
		Low	91	153	147	235	271	371	483
	Type		Tangential					Centrifugal	
Qty		1	1	1	1	1	2	2	
Coil	No. of Rows		3	3	3	3	3	3	3
	Area (sq ft)		1.1	1.7	1.7	2.2	2.2	2.8	2.8
	Connection (in)	Supply	¾NPT	¾NPT	¾NPT	¾NPT	¾NPT	¾NPT	¾NPT
		Return	¾NPT	¾NPT	¾NPT	¾NPT	¾NPT	¾NPT	¾NPT
Drain		½	½	½	½	½	½	½	
Motor	Qty.		1	1	1	1	1	1	1
	V-ph-Hz		220-1-50	220-1-50	220-1-50	220-1-51	220-1-52	220-1-50	220-1-50
	Power Input (w)		32	32	44	57	69	113	164
	Current drawn (A)		0.14	0.15	0.19	0.25	0.31	0.51	0.72
Filter	Qty		1	1	1	1	1	1	1
	Size (mm)		189×391	189×591	189×591	189×790	189×790	189×990	189×990
Dimension	A (mm)		602.5	802.5	802.5	1002.5	1002.5	1202.5	1202.5
	B (mm)		220	220	220	220	220	220	220
	C (mm)**		640	640	640	640	640	640	640
	D (mm)		540	540	540	540	540	540	540
	Approx. Wt (kg)		13	15	15	16	16	28	28

* For more information about selection procedure and capacity tables visit www.ssi.co.ir

** C: indicates height for vertical installation (including supports)

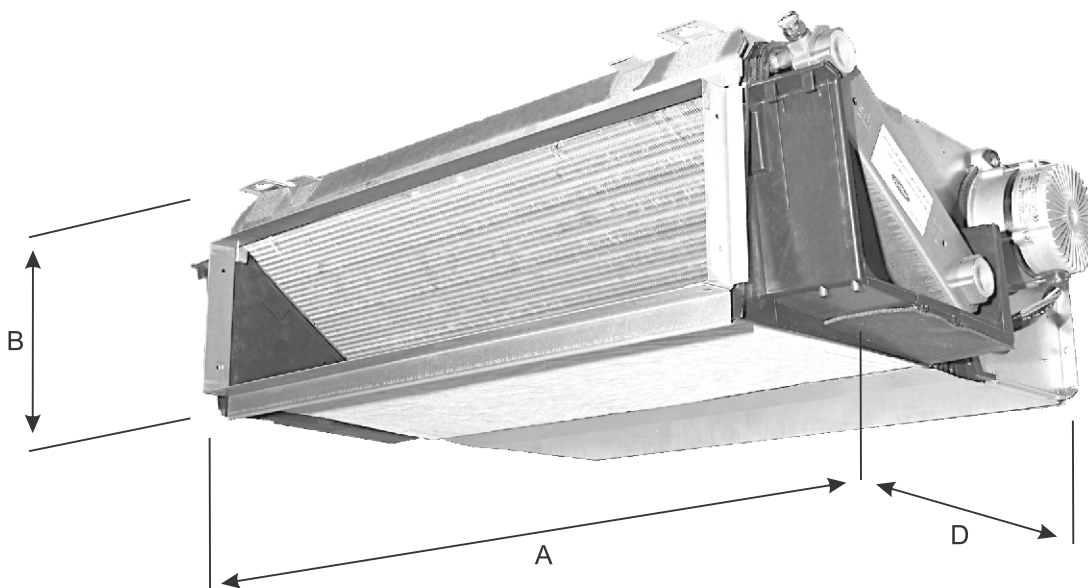

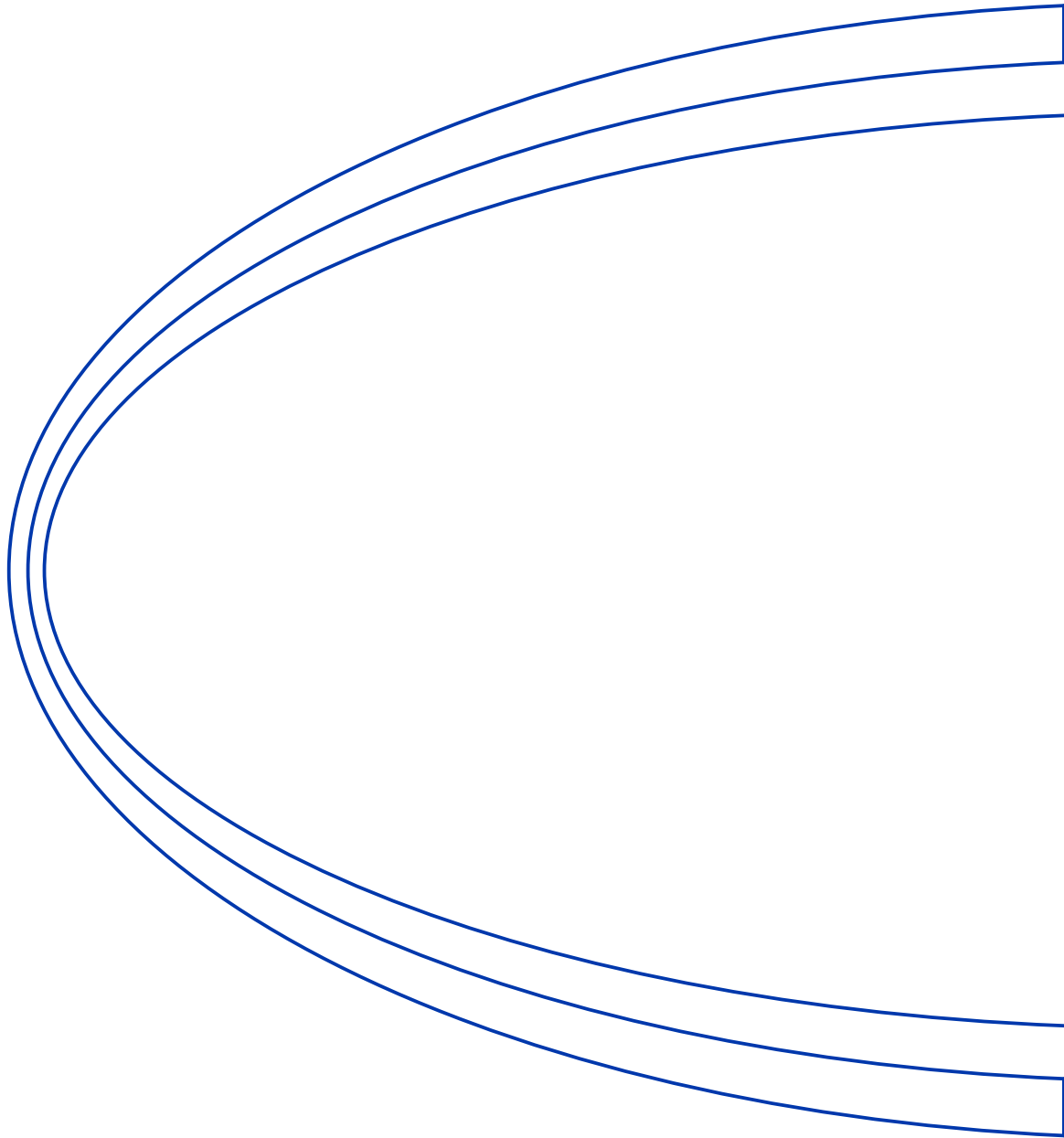

Sanaye Sarmaafarin Iran

شرکت صنایع سرما آفرین ایران
(کریر ترموفریگ)

No. 194, W. Khorramshahr (Apadana) Ave., TEHRAN-15337, P. O. BOX: 13145-1799 Tel: 88762038 Fax: 88762033 www.sarmaafarin.com

سهرودی شمالی، خیابان خرمشهر، شماره ۱۹۴، تهران - ۱۵۳۷۷، صندوق پستی: ۱۷۹۹-۱۳۱۴۵ تلفن: ۸۸۷۶۲۰۳۸ فاکس: ۸۸۷۶۲۰۳۳

Manufacturer reserves the right to discontinue or change at time, specifications of designs without notice and without incurring obligations